

# 4230/6230/9230 SERIES

## OWNERS OPERATION GUIDE

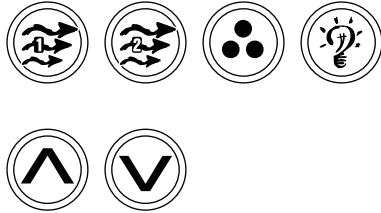

**HYDROQUIP**<sup>TM</sup>

# CONTENTS

<b>Important Safety Instructions</b> .....	<b>2</b>
<b>INTRODUCTION</b>	
<b>Major Component Illustration</b> .....	<b>4</b>
<b>SYSTEM OPERATION</b>	
<b>Features &amp; Function</b> .....	<b>5</b>
<b>Visual Diagnostic System (VDS)</b> .....	<b>6</b>
<b>Spaside Control Operation</b> .....	<b>7</b>
<b>Programming Filtration</b> .....	<b>8</b>
<b>Error Indication</b> .....	<b>8</b>
<b>Spa Light</b> .....	<b>10</b>
<b>OPERATIONAL CONSIDERATIONS</b>	
<b>Warm Weather Conditions</b> .....	<b>10</b>
<b>Filtration System</b> .....	<b>11</b>
<b>Winterizing</b> .....	<b>11</b>
<b>Chemical Water Treatment</b> .....	<b>11</b>
<b>TROUBLESHOOTING</b> .....	<b>12</b>
<b>Warranty Information</b> .....	<b>15</b>
<b>Notes</b> .....	<b>16</b>

# IMPORTANT SAFETY INSTRUCTIONS

## READ AND FOLLOW ALL INSTRUCTIONS

- ! **DANGER** To reduce the risk of injury, do not permit children to use this product unless they are closely supervised at all times.
- ! **WARNING - RISK OF CHILD DROWNING.** Extreme caution must be exercised to prevent unauthorized access by children. To avoid accidents, ensure that children cannot use a spa or hot tub unless they are supervised at all times.
- ! **DANGER** To reduce the risk of injury to persons, do not remove suction fittings.
- ▶ Spa location must accommodate sufficient drainage of water around the base of the structure, as well as the power source compartment.
- ▶ Prolonged immersion in water that is warmer than normal body temperature can result in a dangerous condition known as HYPERTHERMIA. The causes, symptoms, and effects of hyperthermia may be described as follows: Hyperthermia occurs when the internal temperature of the body reaches a level several degrees above the normal body temperature of 98.6F. The symptoms of hyperthermia include dizziness, fainting, drowsiness, lethargy, and an increase in the internal temperature of the body. The effects of hyperthermia include (1) unawareness of impending hazard, (2) failure to perceive heat, (3) failure to recognize the need to exit spa, (4) physical inability to exit spa, (5) fetal damage in pregnant women, (6) unconsciousness resulting in danger of drowning. **WARNING** The use of alcohol, drugs or medication can greatly increase the risk of fatal hyperthermia in hot tubs and spas.
- ! **DANGER - RISK OF ELECTRICAL SHOCK.** Install at least 5 feet (1.5m) from all metal surfaces. (A spa may be installed within 5 feet of metal surfaces if each metal surface is permanently connected by a solid copper conductor attached to the wire connector on the terminal box that is provided for this purpose. Refer to NEC and local codes in effect at the time of installation.)
- ▶ A pressure wire connector is provided on the control box to permit connection of a solid copper bonding conductor between this point and any equipment, metal enclosures of electrical equipment, metal water pipe, or conduit within 5 feet (1.5m) of the unit as needed to comply with local requirements.
- ▶ Bond accessible metal to the dedicated connector on the equipment grounding bus, bond the equipment ground bus to the local common bonding grid as part of the installation in the form of (1) a reinforced concrete slab for support, (2) a ground plate provided beneath the hot tub or spa, or (3) a permanent ground connection that is acceptable to the local inspection authority.
- ! **DANGER RISK OF ELECTRICAL SHOCK.** Do not permit any electrical appliance, such as a light, telephone, radio, or television, within 5 feet (1.5m) of a spa or hot tub.

### To reduce the risk of injury:

- ▶ The water in a spa or hot tub should never exceed 104F (40C). Water temperatures between 100F (38C) and 104F (40C) are considered safe for a healthy adult. Lower water temperatures are recommended for extended use (exceeding 10-15 minutes) and for young children.
- ▶ Excessive water temperatures have a high potential for causing fetal damage during the early months of pregnancy, pregnant or possibly pregnant women should limit spa or hot tub water temperatures to 100F(38C).

Before entering the spa or hot tub, the user should measure the water temperature with an accurate thermometer.

The use of alcohol, drugs, or medication before or during spa or hot tub use may lead to unconsciousness with the possibility of drowning.

Persons suffering from obesity or with a medical history of heart disease, low or high blood pressure, circulatory system problems, or diabetes should consult a physician before using a spa or hot tub.

Persons using medication should consult a physician before using a spa or hot tub since some medication may affect heart rate, blood pressure, and circulation.

### **For Units with a GFCI (Ground Fault Circuit Interrupter)**

This appliance is provided with a ground-fault-circuit-interrupter located on the control box. Before each use and with the unit operating, push the test button. The unit should stop operating and the reset button should appear. Push the reset button. The unit should now operate normally. If the interrupter does not perform in this manner, a ground current is flowing indicating the possibility of electrical shock. Disconnect the power, or unplug from receptacle, until the fault has been identified and corrected.

### **For Cord and Plug Connected Units**

Connected to a grounded, grounding type receptacle only. NEVER connect the spa to an extension cord.

Do not bury the cord.

**WARNING** To reduce the risk of electrical shock, replace damaged cord immediately.

### **For Permanently Installed Units**

A terminal marked "G" or "ground" is provided in the wiring box located inside the equipment compartment. To reduce the risk of electric shock, connect the terminal or connector to the grounding terminal of your electrical service or supply panel with a continuous green insulated copper wire in accordance with National Electric Code Table 250-95 and any other local codes in effect at the time of the installation.

### **For Permanently Installed Units not Provided with an Internal Disconnecting Method**

The electrical supply for this product must include a suitably rated switch or circuit breaker to open all ungrounded supply conductors to comply with Section 422-30 of the National Electric Code, ANSI/NFPA 70 1987. The disconnecting means must be readily accessible to the tub occupant but installed at least 5 feet (1.5m) from the tub water.

### **For Units with Gas Heaters**

**WARNING** - Do not install indoors. This unit uses a gas heater that requires proper ventilation and is intended for outdoor use only.

### **For UL Listed Equipment Assemblies**

Install at least 5 feet (1.5m) from tub water using nonmetallic plumbing. Install blower no less than 1 foot (305mm) above the maximum water level to prevent water from contacting electrical equipment. Install in accordance with the installation instructions.

To reduce the risk of drowning from hair and body entrapment, install a suction fitting(s) with a marked flow rate in gallons-per-minute that equals or exceeds the flow rate marked on the equipment assembly.

# INTRODUCTION

Congratulations on your new purchase. This Equipment or Control System is constructed of the finest materials and assembled under the strictest quality control standards. With proper care and maintenance your system will provide you with many years of reliable performance.

The following pages contain information concerning the operation and care of your system.

## VISUAL DIAGNOSTICS

### LIGHT CONNECTION

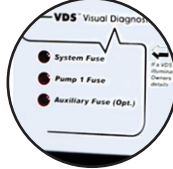

### HEATER ACTIVE



### SMART CORDS

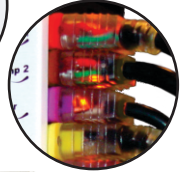

### POWER SWITCH

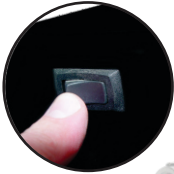

**Note: Your system may differ from the photos above although the basic operation and configuration will be the same.**

# FEATURES & FUNCTION

Your system comes equipped with features you should be aware of.

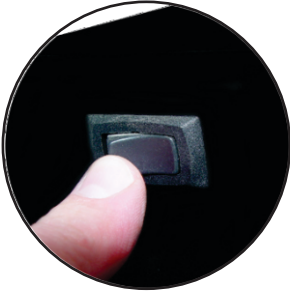

## POWER SWITCH

Your system may have come equipped with a power switch. This switch will turn power to the internal circuitry & attached components on and off.

---



## HEATER ON INDICATOR

All systems are equipped with a “Heater On” indicator to let the user know when the heater is actively heating the spa water.

---

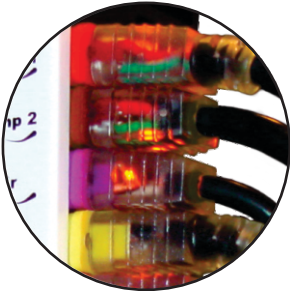

## SMART CORDS

Your system may have come equipped with exclusive “Smart Cords”. These cords have internal illumination to let you know that power is being supplied to the components connected to them. This is a helpful troubleshooting feature should a problem with a component arise.

---

# VISUAL DIAGNOSTIC SYSTEM

If your system is equipped the Visual Diagnostic System, the control will do the troubleshooting for you! VDS consists of control mounted indicators and (if equipped) exclusive “Smart Cords”. You will know at a glance if components are being supplied with proper voltage or if an internal fuse has blown.

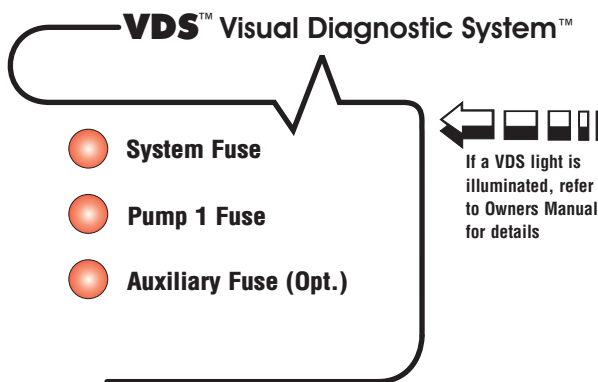

## VDS INDICATOR ILLUMINATED

<p><b>SYSTEM FUSE - This fuse protects the printed circuit board.</b></p>	<p>Input voltage connected incorrectly. Call your local dealer or qualified technician.</p>
<p><b>PUMP 1 FUSE - Protects the primary pump.</b></p>	<p>Restricted flow of water, faulty pump or severe weather/electrical storm. Call your local dealer or qualified technician.</p>
<p><b>AUX. FUSE - Protects the secondary pump or blower.</b></p>	<p>Restricted flow of water, faulty pump or blower or severe weather/electrical storm. Call your local dealer or qualified technician.</p>

# SPASIDE CONTROL OPERATION

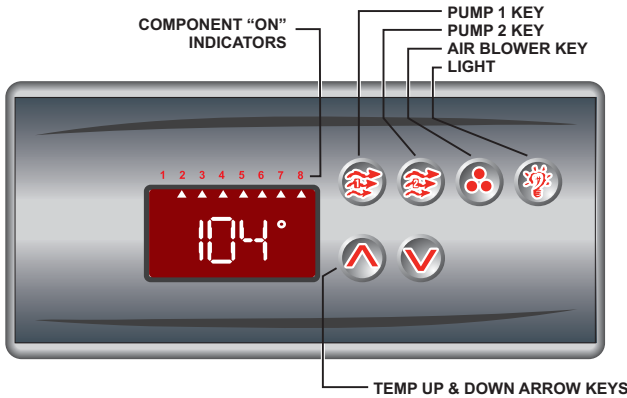

1	Not Used
2	Pump 1 "On"
3	Pump 2 "On"
4	Blower "On"
5	Light "On"
6	Filter Cycle Active
7	Heater "On"
8	Set Temp Displayed



**PUMP 1 KEY:** (If the heater setting has been set above the actual water temperature, low speed will activate on its own as the water is heated). Press this key once to activate the low speed of the pump, press the key a second time to activate high speed and pressing it a third time will turn the pump off. The red indicator in the display window below the Pump 1 icon will illuminate while the pump is on. After 20-minutes the pump will shut off automatically unless done so manually.



**PUMP 2 KEY:** Press this key to turn Pump 2 on and off. After 20-minutes the pump will shut off automatically unless done so manually. The red indicator in the display window below the Pump 2 icon will illuminate while the pump is on.



**AIR BLOWER KEY:** Press this key to turn Blower on and off. After 20-minutes the pump will shut off automatically unless done so manually. The red indicator in the display window below the Blower icon will illuminate while the blower is on.



**LIGHT KEY:** Press this key to turn the light on and off. After 2-hours the light will automatically turn off unless done so manually. The red indicator in the display window below the Light icon will illuminate while the light is on.





**Temperature Set Keys:** Press (or press & hold) the Up/Down Arrow key to increase/decrease the water temperature. The temperature can be adjusted in 1°F increments from 59°F to 104°F (5°C to 40°C). The Set

Point indicator will illuminate in the display window when adjusting the temperature then revert back to the “current” water temperature display. The heater on will illuminate in the display window while the system is heating.

## PROGRAMMING FILTRATION

**Programming Filter Cycles:** Press & Hold the Pump 1 key to show the current setting. Use the Up/Down Arrow keys to adjust the value to 1 (once a day), 2 (every 12-hours) or 3 (every 8-hours) starting the time the system is programmed.

**Programming Filter Cycle Duration:** Press & Hold the Light key to show the current setting. Use the Up/Down Arrow keys to adjust the value to 60 (1-hour), 120 (2-hours), 180 (3-hours) or 480 (8-hours) per cycle. To start a filter cycle immediately, press & hold the Light key. If no key is pressed within 5-seconds the display will revert to the standard monitoring mode.

*\* If the spa is being used during a filter cycle, the cycle will be suspended for 40-minutes or until the spa is no longer in use.*

## ERROR INDICATION

To assist the user in identifying problems with the spa, the system will display an error message. These messages will be helpful when communicating with your local dealer or qualified technician if a problem should arise.



**PRESSURE or FLOW SWITCH ACTIVATED** - This error will be displayed only when the pump is not activated. Cycle the pump through Low & High speeds then off. If the error does not clear this is an indication that the pressure or flow switch is activated with no water flow.

**Contact your local spa dealer**



**PRESSURE or FLOW SWITCH NOT ACTIVATED** - This error will be displayed while the is pump running. Cycle the pump through Low & High speeds. If the error does not clear this is an indication that the pressure or flow switch has not activated although there is water flow.

**Contact your local spa dealer**

## ERROR INDICATION - cont.

Prr

**TEMPERATURE SENSOR MALFUNCTION** - This error will occur when a problem with the temperature sensor exists. This error may also occur if the system is activated while the water temperature is below 35°F.

**Contact your local spa dealer**

OH

**OVERHEAT or HIGH-LIMIT PROTECTION** - There are three(3) stages of over-temperature:

1 - The spa water has exceeded 112°F. The heater, pump and accessory will be deactivated until the water cools to 109°F. *Be sure to check the actual water temperature with an accurate thermometer.*

HL

2 - The spa water has exceeded 119°F. The heater will deactivate while the pump and accessory will still operate. *The blower (if equipped) can be activated to help cool the water. **WATER MUST BE BELOW 119°F AND POWER MUST BE RESET TO CLEAR THE "HL" ERROR***

*A dirty spa filter can also cause a restricted flow of water, be sure the filter is cleaned regularly and ensure all water shutoff valves are open.*

*If the system has been operating normally until now, the pump may be overheating the spa. Refer to "Programing Filtration" on page X and reduce the duration and/or number of cycles per day.*

3 - If you've eliminated items 1 & 2 as problems, the high-limit sensor may have malfunctioned.

**Contact your local spa dealer**

FREE

**FREEZE PROTECTION** - There are two(2) levels of freeze protection integrated into the system.

1 - SMART WINTER MODE, this mode will activate any time the temperature falls below 59°F. This mode will be active for a period of 24-hours. In this mode, if a pump has not been activated in the last 2 hours, the system will automatically turn it on for 1-minute to prevent freezing. The "Filter Cycle" indicator will illuminate while this mode is active.

2 - If the spa water temperature drops below 49°F, the heater & pump will be activated until the water temperature reaches 50°F. **While freeze protection is active no other functions will be possible.**

## SPA LIGHT

Your control may contain a high intensity, low voltage light to enhance nighttime use.

This illustration shows how and where to find the bulb for replacement. It also shows the mounted spa light with a replacement (colored) lens. Colored lenses will further the enhancement of the light. Simply snap on or off to change the mood of your spa.

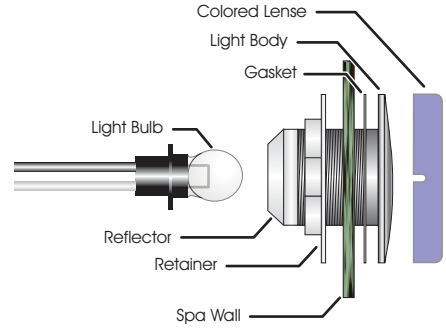

## OPERATIONAL CONSIDERATIONS

The following describes situations you may encounter and situations to be aware of.

### WARM WEATHER CONDITIONS

Since your spa will normally be expected to maintain warm to hot water to be ready for your use, a great deal of attention has been directed to the **energy conservation** detail of insulation so as to keep electrical costs down. This **energy conservation efficiency** may be achieved by extensive insulation of the skirt, plumbing and spa shell, and in some climates full foam insulation may have been provided.

This **energy conservation** feature may cause an inconvenience during warmer times of the year. During warm periods of the year, the temperature within the equipment compartment can elevate to a point that the pump will automatically turn off for a short period of time (15-30 minutes) to allow the pump to cool down before automatically restarting. This cool down feature will not harm your spa but serves only to protect the pump from damage and as an indicator that it is too hot. To minimize this occurrence, refrain from using your Hydrotherapy Jets for prolonged periods of time during warm seasons.

The jet pump chosen for your spa has been specifically sized for *maximum performance* and your Hydrotherapy enjoyment.

## FILTRATION SYSTEM

Please refer to your Spa Manufacturer's owner's manual regarding the operation, maintenance and cleaning of your filtration system.

Dirty or clogged filters can cause flow restrictions and you may experience difficulty in reaching and/or maintaining desired heat levels.

## WINTERIZING

When freezing weather and/or power losses are expected, contact your local spa dealer for freeze protection or winterizing recommendations for both the spa and the equipment system. Freeze related damage is not covered by the warranty.

## CHEMICAL WATER TREATMENT

Your dealer is familiar with local water conditions and which chemicals are compatible with the water and are designed specifically for your spa. This is the best person to advise you on proper water quality management.

The one thing you can do to insure years of trouble free equipment operation is to maintain proper water chemistry.

Two basic goals of the chemical water treatment are sanitizing and balancing the water.

Sanitizing simply means keeping the water free from living microorganisms including algae, bacteria and viruses. The current most popular chemicals for sanitizing include chlorine, bromine and ozone.

Balancing water means establishing a balance among pH, total alkalinity and total hardness. Water that is unbalanced can corrode the spa and it's support equipment or leave deposits of minerals. Properly balanced water is essential to allow the sanitizing chemical to work effectively. There are numerous chemical additives to help you in controlling pH, total hardness and total alkalinity. **NEVER** use softened water when filling your spa. Softened water is extremely corrosive to the metal parts of the spa equipment and may lead to an unforeseen failure.

Sometimes, despite your most diligent efforts, your water may become too far out of balance to be managed chemically. At this point it is probably better to drain and clean the spa and start over with fresh water.

Equipment failure caused by improper water chemistry will not be covered under warranty.

# TROUBLESHOOTING

*The following describes situations and possible solutions to common problems you may encounter as a spa owner.*

## NOTHING OPERATES

- Main Breaker is OFF** - *Set to On.*
- Sub-Panel Breaker Off** - *Set to On.*
- Power switch in Off position** - *Set to On.*
- Component(s) not plugged in** - *Plug in components.*
- Power cord not plugged in** - *Plug in power cord.*
- Over-Temperature Protection On** - *Refer to page 9*

## NO, LOW OR SURGING WATER FLOW

- Air Lock in Plumbing System** - *“Bleed” the system.*
- Restricted Flow** - *Insure that the water shut-off valves are open and that suction fittings are not blocked by debris.*
- Dirty Filter** - *Clean or replace filter.*
- Low Water Level** - *Increase water level to recommended level.*

## NO LOW SPEED PUMP OPERATION

- Low Level Programming Incorrect** - *Contact your local dealer.*
- Over-Temperature Protection On** - *Refer to page 9*
- Pump Not Plugged-In** - *Plug in the Pump.*

## NO JETS OR BLOWER OPERATION

- Blower or Pump Not Plugged-In** - *Plug in the Blower or Pump.*
- Over-Temperature Protection On** - *Refer to page 9*

## NO THERAPY JET OPERATION

- Water Shut-Off Valves are Closed** - *Open Shut-Off valves.*
- Dirty Filter** - *Clean or replace filter.*
- Jets Not Properly Adjusted** - *Adjust Jets*
- Diverter Valve Not Properly Adjusted** - *Adjust diverter valve*
- Thermal Overload Tripping** - *Check for restricted flow of water.*
- Over-Temperature Protection On** - *Refer to page 9*

## WATER LEAKS

**Spa Overfilled** - *Adjust water level.*

**Too Many People in the Spa** - *Adjust water level.*

**Drain-Valve Left Open** - *Close drain valve.*

**Couplings or Unions Loose** - *Tighten or contact your local dealer.*

**Pump Seal Leaking** - *Contact your local dealer.*

**Plumbing Connections Leaking** - *Contact your local dealer.*

**Water Leaking from Spaside Control** - *Contact your local dealer.*

**Water in Air Blower Plumbing** - *Contact your local dealer.*

## NO HEAT

**Temperature Not Set Correctly** - *Adjust Set Point.*

**Over-Temperature Protection On** - *Refer to page 9*

**Current Limiting On** - *120V Systems will not heat if High-Speed or Blower is on. Contact your local dealer.*

**No Power** - *Reset breaker at service panel.*

**Low Water Flow** - *Clean or Replace filter.*

**Pressure Switch Not Adjusted Properly** - *Contact a qualified technician.*

## HIGH HEAT

**Temperature Sensor Not in Dry-Well** - *Place sensor in dry-well.*

**Temperature Set Too High** - *Adjust Set Point.*

**High Ambient Temperature** - *Remove spa cover.*

## GFCI TRIPS OCCASIONALLY

**Lightning or Electrical Storm, Power Surge, Extremely Humid Conditions, or Radio Frequency Interference** - *Reset GFCI.*

*NOTE: GFCI must be properly grounded and bonded.*

## GFCI TRIPS IMMEDIATELY

**Defective Component** - *Contact a qualified service technician or the factory for assistance.*

## NO LIGHT OPERATION

**Light Bulb Defective** - *Replace bulb or contact your local dealer.*

**Reflector has Fallen Off** - *Replace reflector or contact your local dealer.*

**Light Not Plugged-In** - *Plug in the Light.*

# SYSTEM DATA LABEL

*The system data label is located on the control box. This label is very important and contains information you will need to establish your electrical service. The voltage and amperage ratings are shown on the bottom of the label. Product, Model, Serial and Code numbers are also shown on the label.*

**Note:** *This information will be necessary if you should ever have to request warranty or any other type of service.*



**HYDROQUIP™**  
THE **SMART CHOICE™**  
Corona, CA 92880 | [www.hydroquip.com](http://www.hydroquip.com)

REFER TO NEC FOR  
BREAKER SIZING

**ORDER CODE:** CSXXXX  
**MODEL:** XXXXXXX-XXXXXXX  
**CODE:** XXXX-XXXX-XXX  
**VOLTS:** 120 240  
**AMPS:** SEE RATINGS LABEL  
**PRODUCT:** HQXXXX

## WARRANTY INFORMATION

To all original purchasers, **HYDROQUIP** warrants its products to be free from defects in material and workmanship for a period of one year from the date of purchase.

**HYDROQUIP** will repair or replace the part, which in our opinion, is defective.

This warranty excludes damage as a result of: normal wear, freezing, low voltage, chemical abuse, accident, negligence, alteration, improper installation, use or care.

To obtain warranty service, return defective products within the warranty period to **HYDROQUIP**.

Purchaser is responsible for removal or reinstallation labor, freight charges, or any other such costs incurred in obtaining warranty service.

**HYDROQUIP** assumes no responsibility for incidental or consequential damages. Some states do not allow the exclusion of incidental or consequential damages, so the above limitations and exclusions may not apply to you. This warranty gives you specific legal rights and you may also have other rights, which vary from state to state.

**THE SPA DEALER MAY PROVIDE A DIFFERENT WARRANTY,  
CONTACT YOUR SPA DEALER FOR DETAILS**



# NOTES

*Use this section to jot down any information you may need at a later date.*

**Dealer:** \_\_\_\_\_ **Date of Install:** \_\_\_\_\_

**Contact:** \_\_\_\_\_ **Phone:** \_\_\_\_\_

**Address:** \_\_\_\_\_

**City:** \_\_\_\_\_ **State:** \_\_\_\_ **Zip:** \_\_\_\_\_

**Notes:** \_\_\_\_\_

---

---

---

---

---

---

---

---

---

---

---

---

---

---

---







**HYDROQUIP**<sup>TM</sup>

510A N. Sheridan Street · Corona, CA 92880-2024

Email: [info@hydroquip.com](mailto:info@hydroquip.com) · Internet: <http://www.hydroquip.com/>

Telephone: 951.273.7575 · Fax: 800.332.7190